

圆柱头内径数显卡尺

136系列

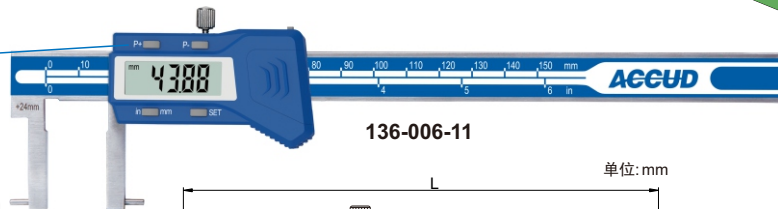

ACCUD



- ◆ 用于测量狭窄内凹处的相关尺寸
- ◆ 分辨率: 0.01mm/0.0005"
- ◆ 按键: 公/英制转换, 设置数值, 数值预置(P+, P-)
- ◆ 滑动开机, 自动关机
- ◆ 带数据输出
- ◆ 不锈钢尺身

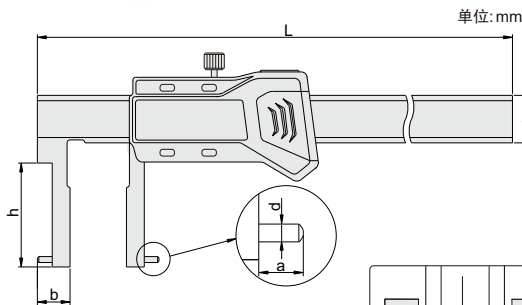

500mm以上芯片

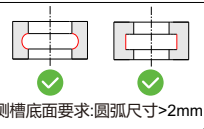
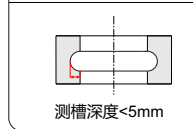
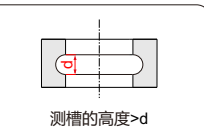
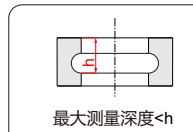
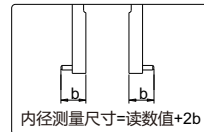
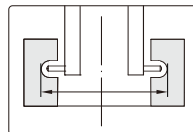

货号	量程	精度	a	b	c	d	h	L
136-006-11	24-150mm	±0.04mm	5	12	16	∅2	30	250
136-008-11	25-200mm	±0.04mm	5	12.5	16	∅2	40	310
136-012-11	50-300mm	±0.07mm	8	25	17	∅3	80	410
136-020-11	80-500mm	±0.07mm	16	40	24	∅3	90	680
136-006-12	35-150mm	±0.05mm	6	17.5	16	∅2	60	250
136-008-12	40-200mm	±0.05mm	7	20	16	∅2	70	310
136-012-12	30-300mm	±0.05mm	5	15	16	∅3	50	410
136-020-12	80-500mm	±0.08mm	16	40	24	∅3	150	680

卡尺